

USA
TX

MX
REY
MTY

precision-group.com



PrecisionGroup



PMI Servicios de
Exportación

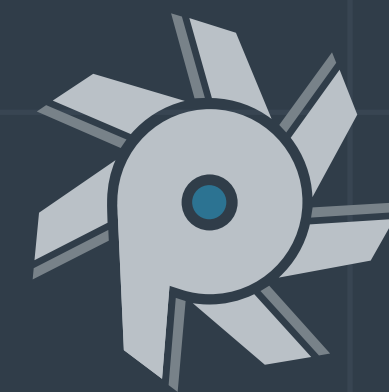

Prod mash



In mold manufacturing
and repair,

choosing
Precision is
the smart
choice

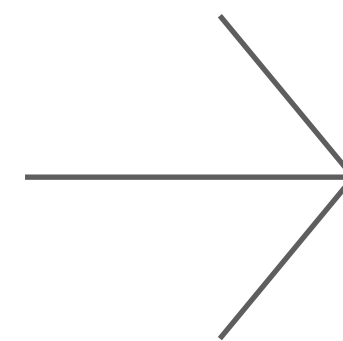

Precision Group®, along with its companies **Prodmash**® and **PMI**® offer you the support of an international company recognized for its processes, experience and commitment to quality.

We guarantee that no matter the challenge, when it comes to design, mold fabrication, modification, engineering changes, mold repair and plastic injection molding, we will always be the right decision.



Culture based on excellence

Precision Group has more than 5 decades experience offering solutions in designing, fabricating and repairing molds for various industries.

We understand the challenges that our customers face.

We live a **Culture of Precision** that is based on 3 promises

01

Every detail speaks of us.

We are systematic in every step of our quality process.

02

Our commitment never ends.

We make monitoring part of our service and innovation part of our growth.

03

Be empathetic without sacrificing excellence.

We deliver the best work in the best time possible.



Services

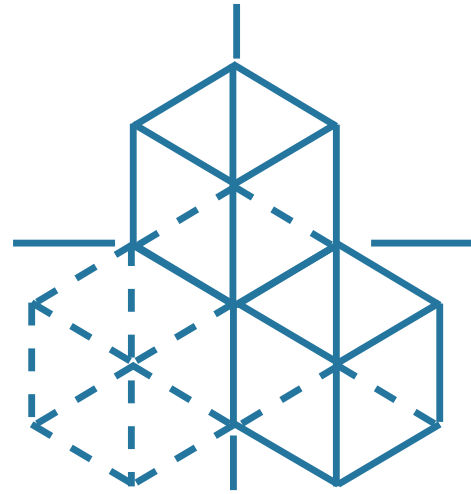

/ Engineering Design

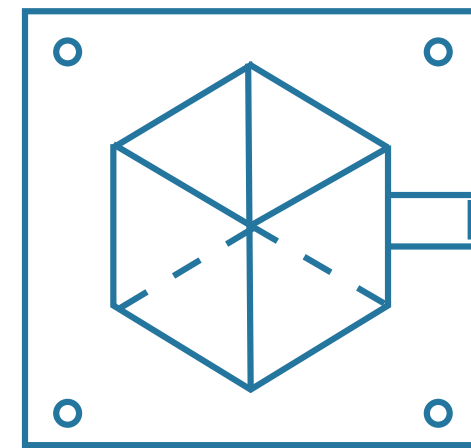

/ Plastic Injection Molding

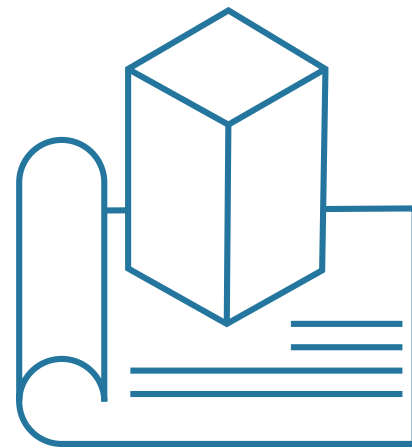

/ Prototyping

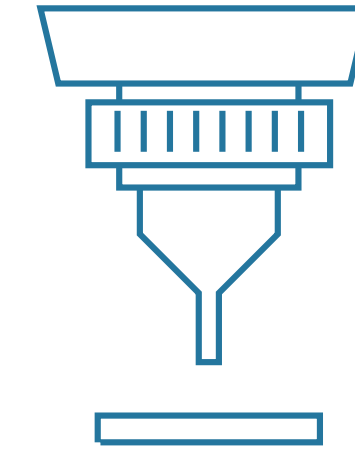

/ Machining

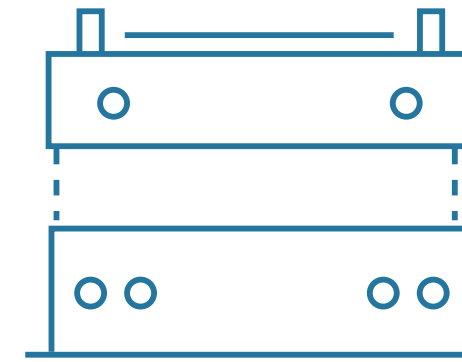

/ Mold Manufacturing

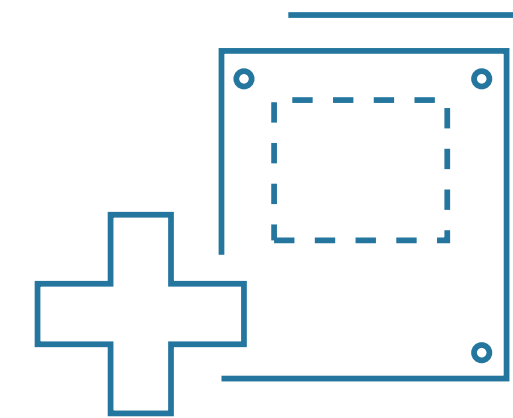

/ Mold Repair



We offer services to the United States, Mexico and Latin America from our 4 locations:



Certifications

ISO9001:2015

Manufacture of molded plastic components for medical, automotive, electronics and consumer devices.

ISO13485:2016

Manufacture of molded plastic components for medical devices.

Process Precision Group

Every moment of our process is an opportunity to demonstrate our commitment to quality.



Design

- From idea to concept and development
- Design of products
- 3D design
- Concept style and layout

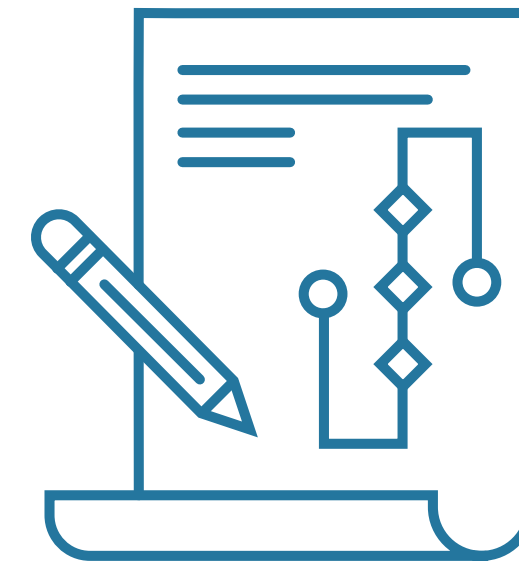

Planning and Programming

- Discovery
- Technology survey
- Proposal

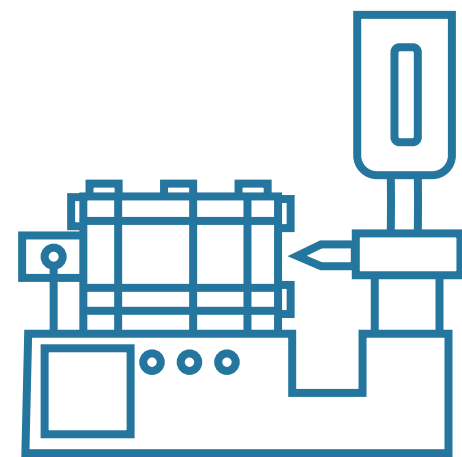

Production or Maintenance

- Prototyping
- Machining
- Mold Manufacturing
- Repair or preventative maintenance

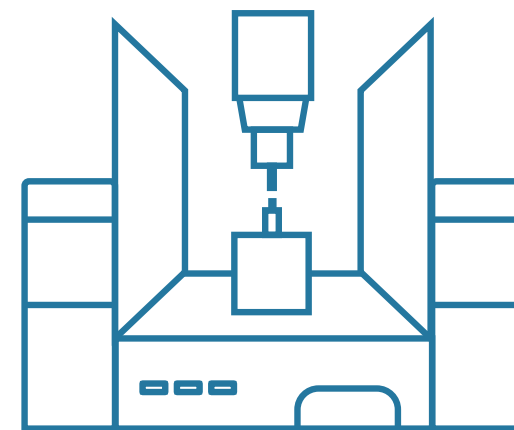

Injection Molding

- Production
- Assembly
- Secondary operations

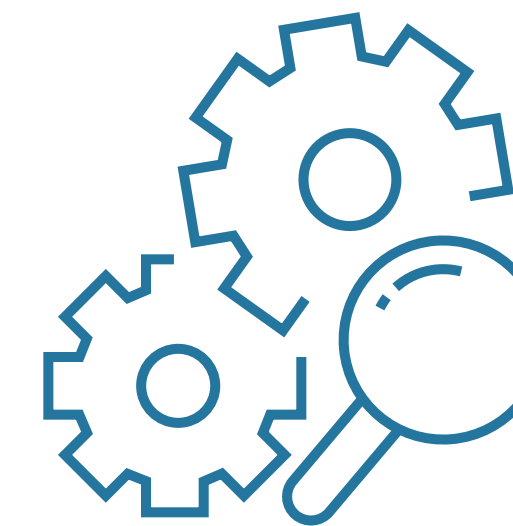

Quality Control

- Dimensional analysis
- Inspection

At Precision Group our mission is simple: we aim to provide a seamless transaction while, at the same time, guaranteeing customer satisfaction.

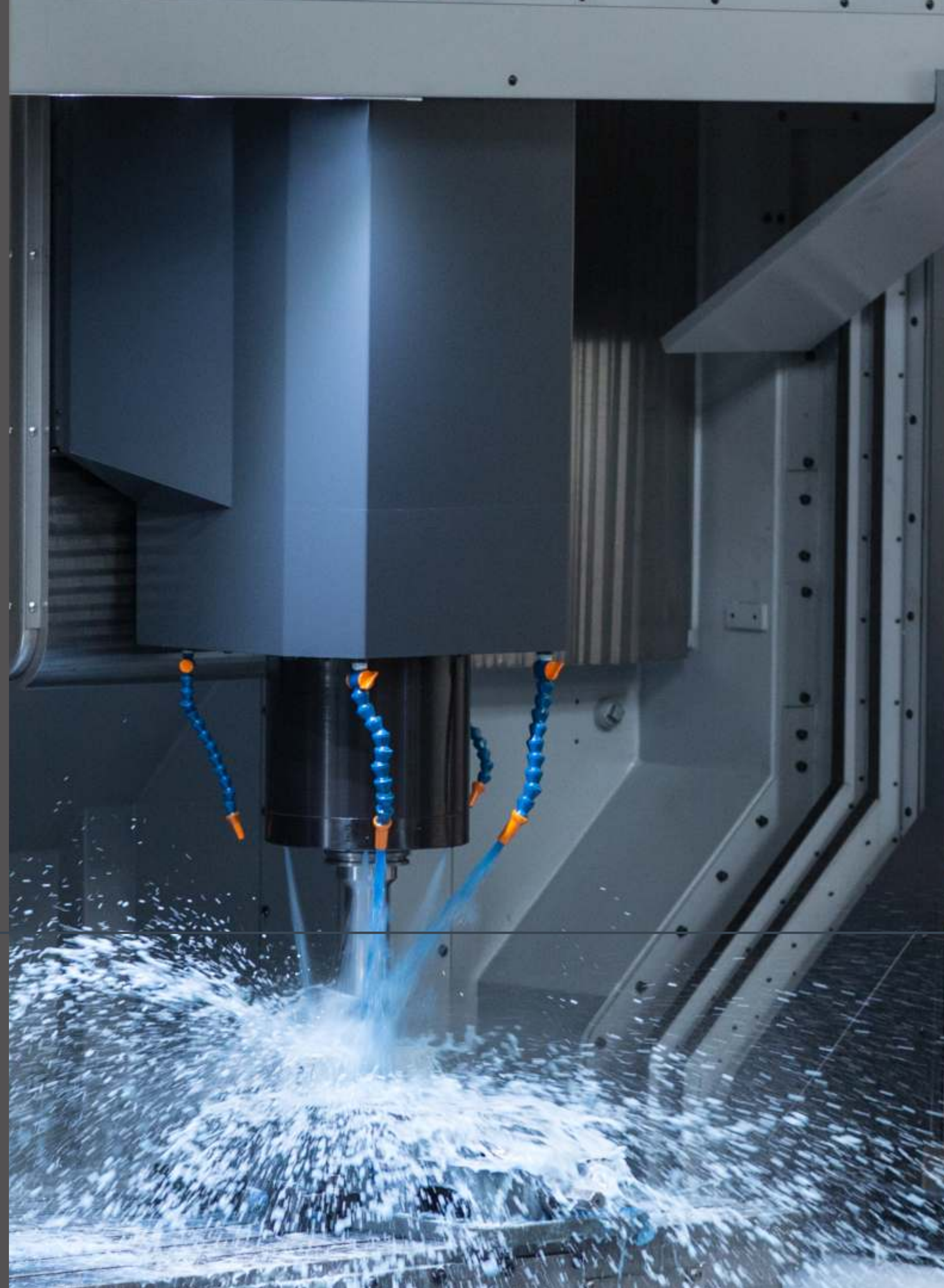

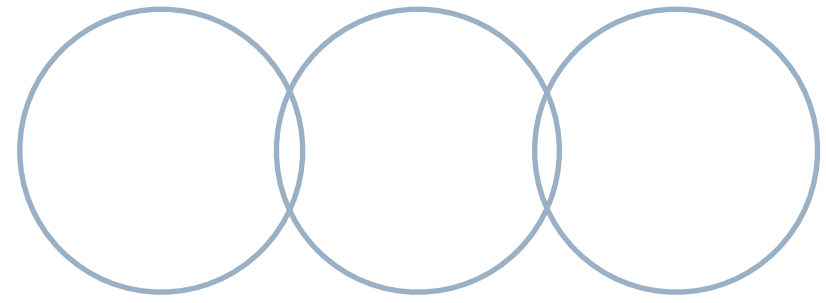

Trusted across many industries.

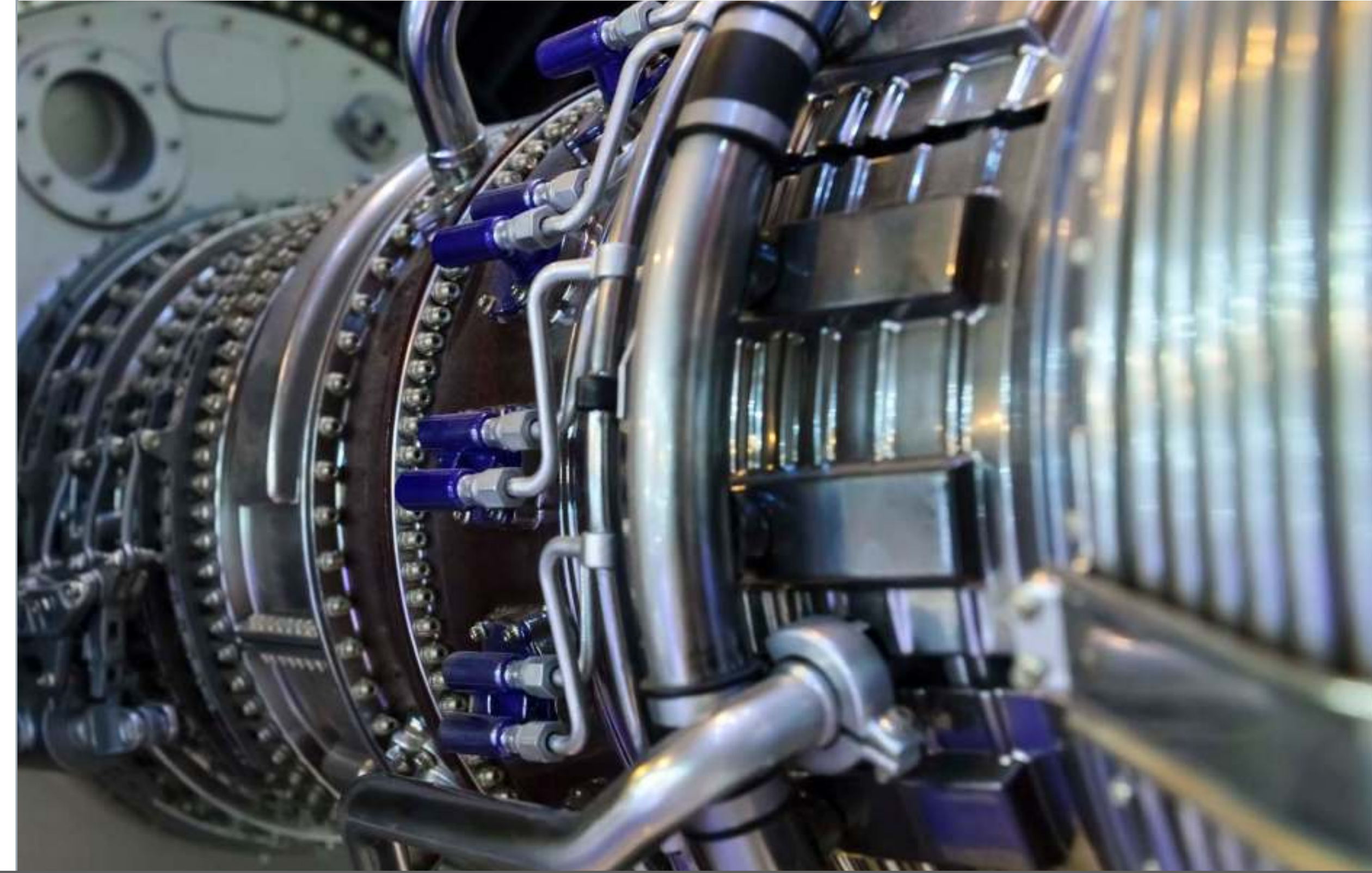

Medical



Science and Technology

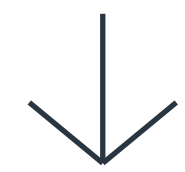

Electronics



Consumer



Energy

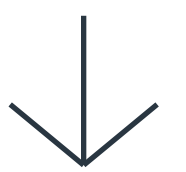

Automotive

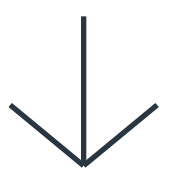

01

Medical

We are leaders in the development of components for the medical sector. We hold ISO9001: 2015 and ISO13485: 2016 certifications, and we have the experience and ability to meet the standards of brands like Alcon Surgical, Omron and Thermo Fisher (with whom we work to produce coronavirus test kits).

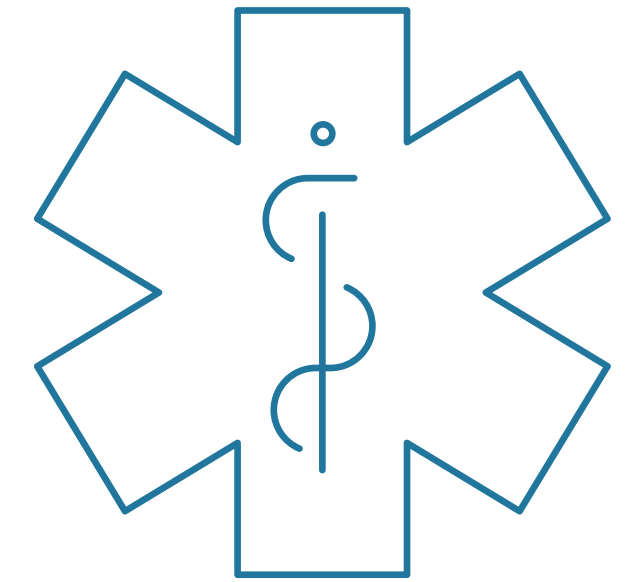

02

Science and Technology

We have collaborated with leading research institutions such as Princeton University and the Southwest Research Institute. Additionally, we have collaborated with NASA on projects such as the Interstellar Frontier Explorer (IBEX) and New Horizons, the first interplanetary space probe to fly over Pluto.

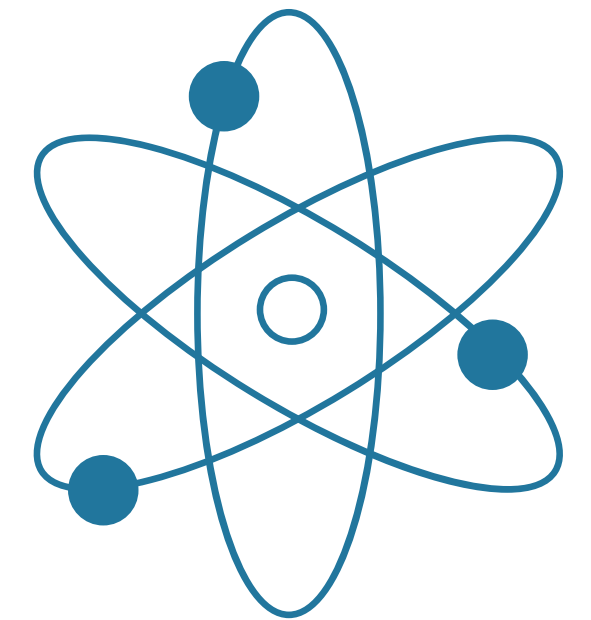

03

Electronics

We have extensive experience in the design, manufacture and maintenance of plastic injection molds to contribute to the development of fiber optic systems for cable, internet and telecommunication applications. We have worked for Corning Cable, Panasonic and Headset Advisor.

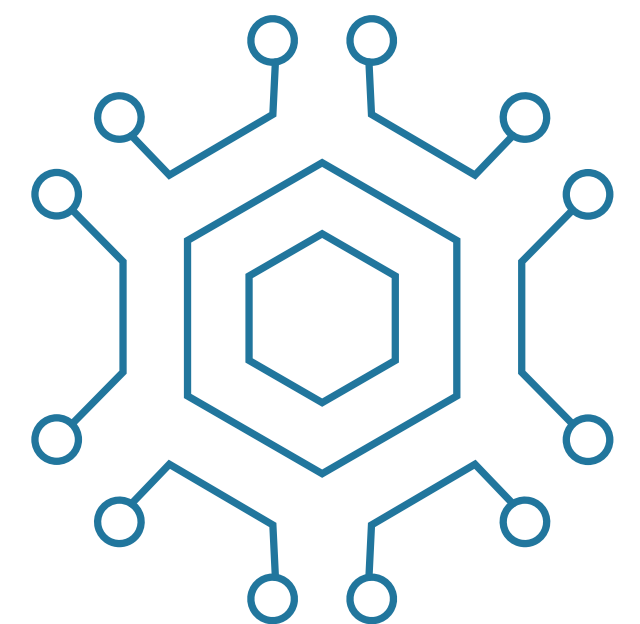

04

Consumer

We are ready to take your consumer product from the idea phase to manufacturing and mass production. We have collaborated with a diverse set of companies in the sector such as Black & Decker, Igloo Corporation, Coleman Corporation, General Electric, and many others.



05

Energy

Whether your product is wind turbines, oil pumpjacks, solar panels, or high pressure containers, Precision Group can help energy companies by building and repairing molds, executing complex machining, engineering design and producing injection molded components.



06

Automotive

We have the experience and ability to fabricate molds for automotive exterior and interior assemblies, engine components, fluid control systems, wire harnesses for underhood applications, textured surfaces in need of repair and more. International companies like GM, Toyota, Ford and Chrysler trust us.

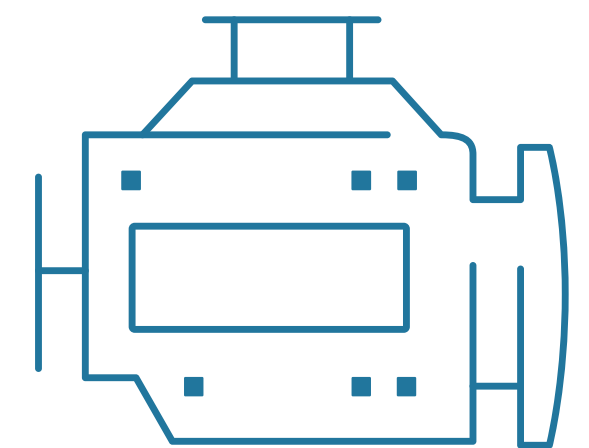

Put your project in the hands of the experts.

Contact us for a quote.



San Antonio

315 North Park Drive
San Antonio, Texas 78216

Domingo Auces
dhauces@pmttool.com
210 901 0828

La Feria

301 Industrial Way
La Feria, Texas 78559

Juan Garza
jgarza@pmttool.com
956 797 4032

Nuevo León

Carretera Mezquital – Santa Rosa #2745
interior 7
Apodaca, Nuevo León
México, CP 66630

Frederic Charge
fcharge@pmttool.com
011 52 81 2010 0782

Reynosa

Brecha E99 Local #1C
Parque Industrial Reynosa
Reynosa, Tamaulipas, México CP 88780

Javier Treviño
jtrevino@pmttool.com
011 52 89 9283 9412
956 535 3728



PrecisionGroup

www.precision-group.com